

# Bodenträger- und Regalschienen zum Einlassen

## Häfele - Bodenträger - System

Bodenträgerschiene

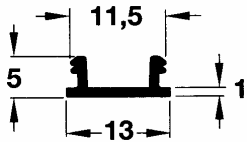

C42.5.285

Bodenträger

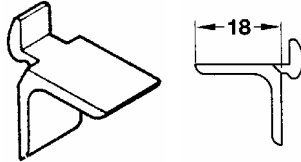

C42.5.286

Material: Schiene und Träger aus Aluminium natur blank  
Stablänge: 3,50m, Abgabe nur in ganzen Stäben!

Zum Einschlagen in Nut

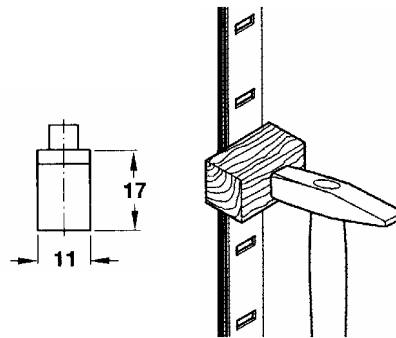

Notwendige Nut-Abmessung:

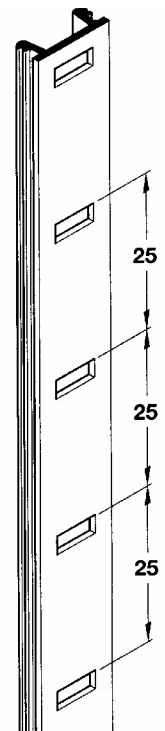
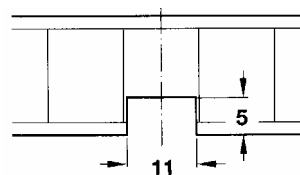

## Bodenträger - System aus Stahl

Bodenträgerschiene

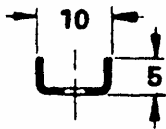

Material: Stahl vernickelt, L=3,50m

C42.5.287

Bodenträger

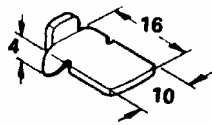

Material: Stahl vernickelt

C42.5.288



## Bodenträger, abgeflacht

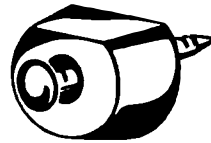

C42.4.168

Material: PE  
Farbe:  
weiß, braun

## Sparrings REGALSYSTEM

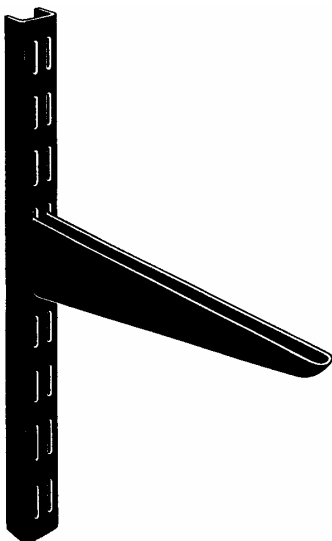

Art.-Nr.	Länge
Wandschiene	
C42.5.375	96 cm
C42.5.376	160 cm
C42.5.377	192 cm
C42.5.378	224 cm

Art.-Nr.	Länge	Tragkraft
Träger		
C42.5.380	17 cm	75 kg
C42.5.381	22 cm	75 kg
C42.5.382	27 cm	75 kg
C42.5.383	32 cm	50 kg
C42.5.384	37 cm	verstärkt
C42.5.385	47 cm	verstärkt

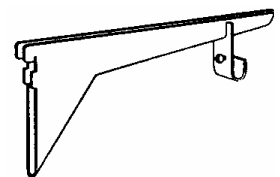

A5.389  
Träger 37cm mit  
Lager für  
Konfektionsstange

Diessner GmbH

Moritzstraße 29  
65185 Wiesbaden

☎ 0611 - 300 355  
☎ 0611 - 30 78 29

Email info@diessnergmbh.de  
Internet www.diessnergmbh.de