

I-System – Verbindungselemente & Kleinteile

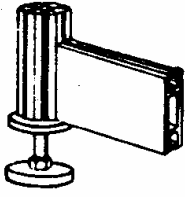

Die **Konterscheibe** verhindert ein Abrutschen der unteren Zarge bei Belastungen über 50 kp

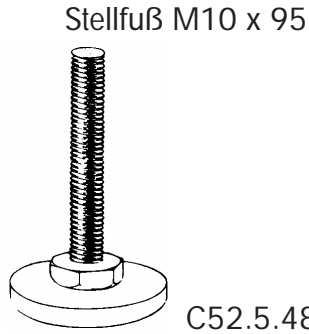

Stellfuß - neu
M8x70
mit Scheibe
(keine Gewindebohrung in der Säule notwendig!)

C52.5.4881



Montagebohrung für Exzentrerschloß incl. Montage

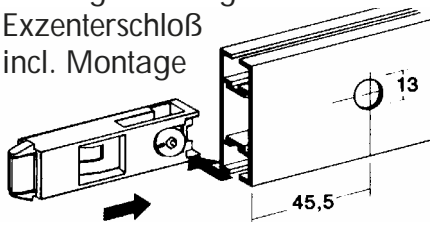

C52.5.511

Exzentrerschloß 20
verzinkt

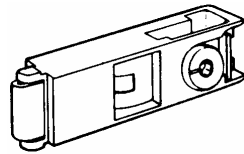

C52.5.483

Adapter für Exzentrerschloß 20 auf

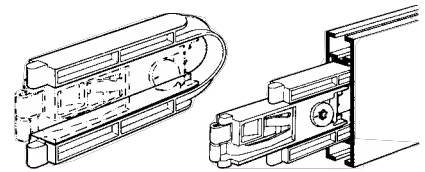

C52.5.484

Montage des Gehrungswinkels

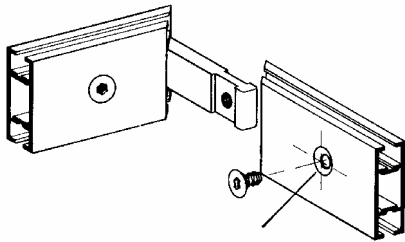

Senkbohrung $\varnothing 6.4/\varnothing 12$

Gehrungswinkel 20

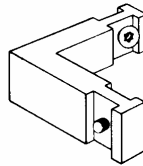

C52.5.485

Gehrungswinkel 40

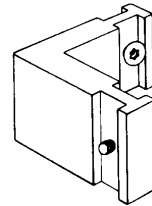

C52.5.486

Montage Eckverbinder

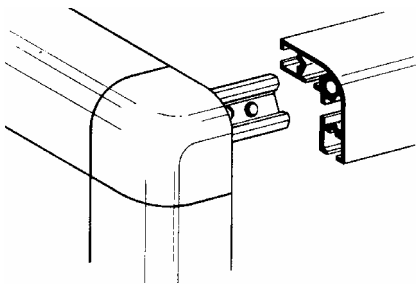

Eckverbinder

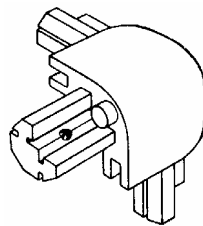

C52.5.490

Eckverbinder mit Gewinde M10

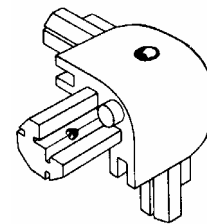

C52.5.491

Diessner GmbH

Moritzstraße 29
65185 Wiesbaden

Email info@diessnergmbh.de
Internet www.diessnergmbh.de

☎ 0611 - 300 355
☎ 0611 - 30 78 29